







FRONTBEFESTIGUNG

Die Frontmontage muss die maximale Einbautiefe angegeben werden. Der Insektenschutz wird mit reduzierten Maßen geliefert, abhängig von der benötigten Version der Frontmontage. Z. B. Max Einbautiefe Version A: die Lieferung des Insektenschutzes erfolgt reduziert um 30mm in der Breite un 15mm in der Hoehe.



FRONTBEFESTIGUNG VERSION

		
A	B	C
Article-Nr. ALLU0858VA	Article-Nr. ALLU0858VB	Article-Nr. ALLU0858VC
		
D	E	F
Article-Nr. ALLU0858VD	Article-Nr. ALLU0858VE	Article-Nr. ALLU0858VF

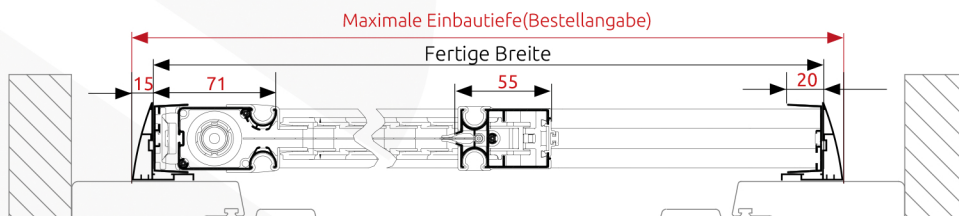
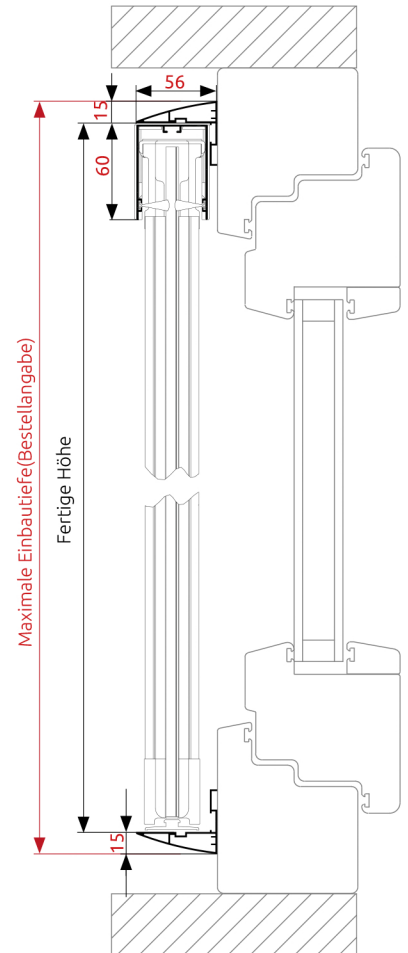

FRONTBEFESTIGUNG PROFIL

Artikel-Nr. ALLU0858
Montagerahmenprofil
für Frontbefestigung

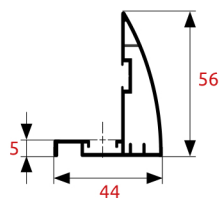

Mit standard obere Führungsschiene und Anschlagprofil

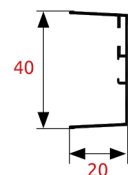
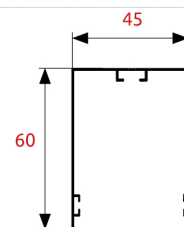

FARBEN

PROFILFARBEN				AUFPREIS				
PROFILFARBEN	9016 glänzend	9006 matt	7016 matt	Silber Elox + 4% Rohstoffe + 10% Fertige Produkte	8017 halbglänzend	8014 matt	8077 matt	8001 matt
ZUBEHÖRFARBEN	 Schwarz		 Schwarz			 Schwarz		
BÜRSTENFARBEN	 Schwarz		 Schwarz			 Schwarz		
PROFILSONDERFARBEN		Preise auf Anfrage						